

# FINGERSAFE MK1C

## FITTING INSTRUCTIONS

### FOR COMMERCIAL ALUMINIUM FRAMED DOORS

*Fingersafe is easy to fit and very reliable when installed correctly. It is essential that these instructions are followed carefully. We can accept no liability or responsibility for incorrect installation. Fingersafe can be installed in 95% of doors, however, it is not suitable for the following types of doors; double swing doors; doors with rising or declining butt hinges; sliding doors.*

#### COMPONENTS OF MK1C

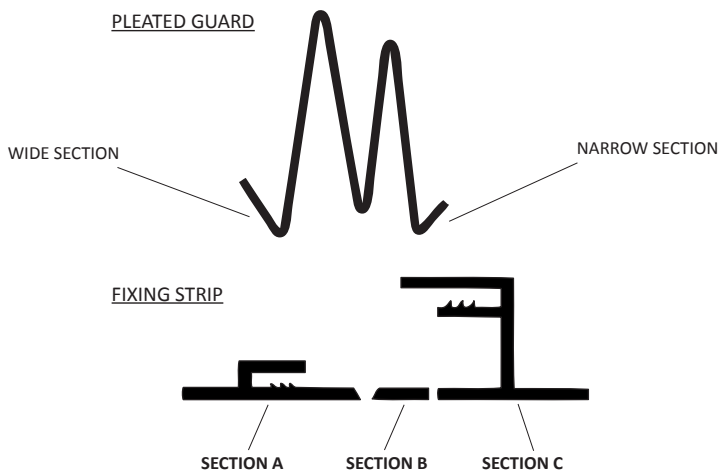

**Use a stanley knife to cut the strip into sections A, B and C before commencing installation.  
Discard section B.**

#### STEP 1

Check the firmness of the door hinges to check for damage and to be sure the door closes- if the door closes easily without Fingersafe it will continue to do so once Fingersafe MK1C is fitted.

#### STEP 2

The MK1C is designed to fit a standard height door of 2050mm. If the door being fitted is less than this standard height, cut the pleated guard with sharp scissors or tin snips- and cut the fixing strip with a hacksaw- to fit the height of the door less 20mm for clearance.

### STEP 3

With the door closed, use a wooden block and a marking pen to draw a guideline on the frame, 7mm from the door stop. Repeat on the door, marking 10mm from the door stop.

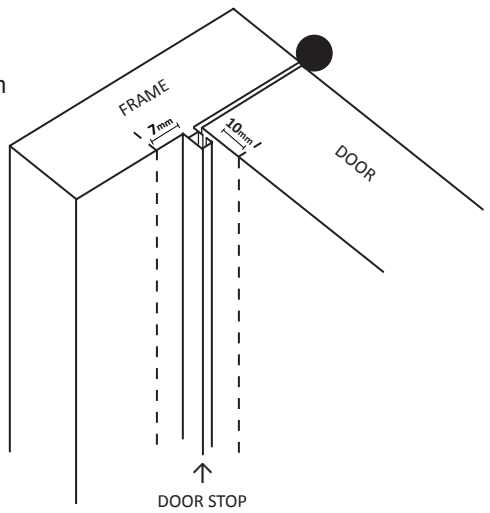

### STEP 4

Hold section C along the guideline on the frame, aligning it with the bottom of the door. Once in position, insert TEK screws provided to fasten.

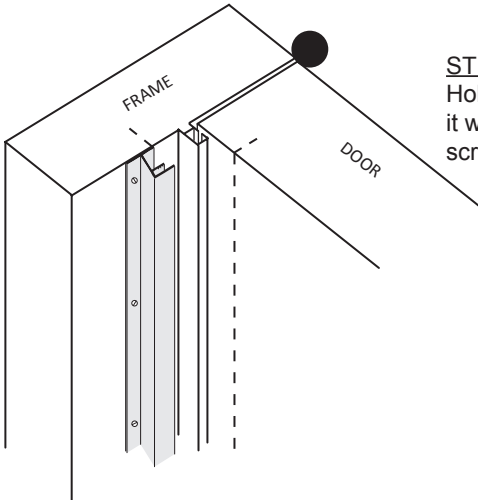

### STEP 5

Hold section A along the guideline on the door, aligning it with the bottom of the door. Insert the TEK screws to fasten.

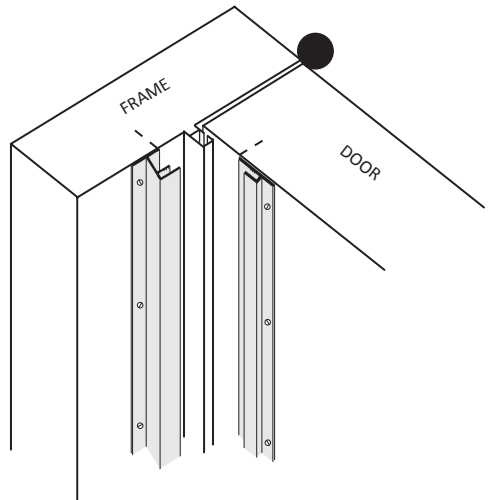

### STEP 6

With the door open at a 90° angle, align the wide section of the pleated guard with the section C (frame-side) fixing strip. Starting at the top and moving downwards, snap the pleated guard into the fixing strip, being sure that it is fully locked into the serrations. (Three distinct clicks signal a secure installation.)

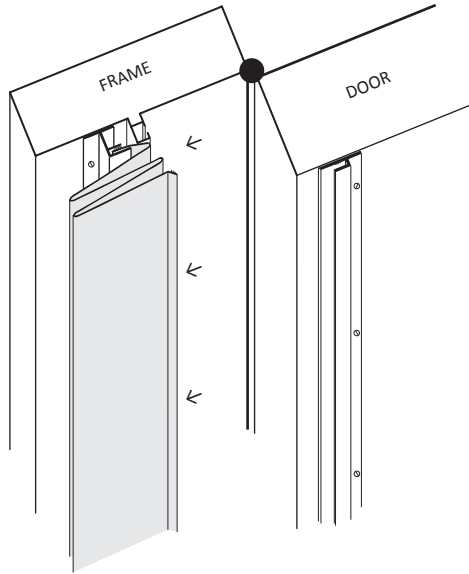

### STEP 7

Align the narrow section of the pleated guard with the section A (door-side) fixing strip. Starting at the top and moving downwards, snap the pleated guard into the fixing strip, being sure that it is fully locked into the serrations. (Three distinct clicks signal a secure installation.)

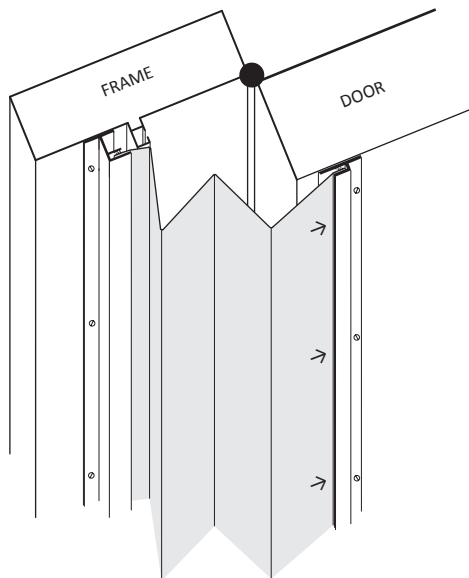

## STEP 8

Add TEK screws as shown below (3 screws for each the frame side and door side). This will ensure the pleated guard is secured to the fixing strips.

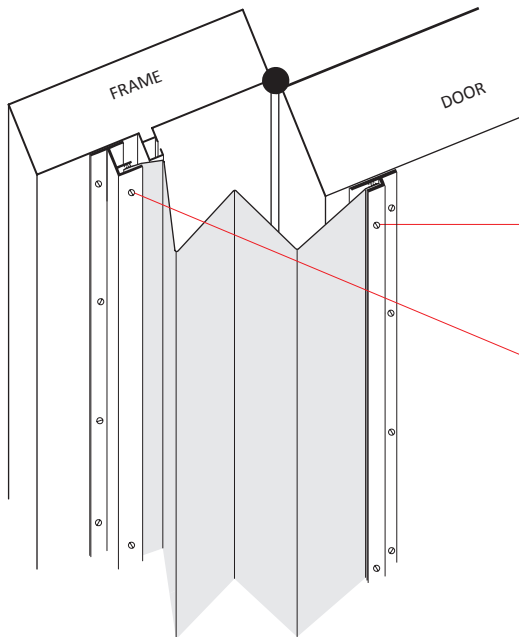
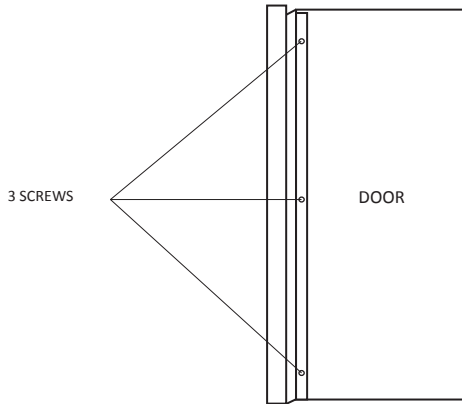

### DOOR-SIDE

Ensure when screwing into door side the screw should go through both the fixing strip and the pleated guard as shown.

### FRAME-SIDE

Ensure when screwing into door side the screw should go through both the fixing strip and the pleated guard as shown.

**THESE INSTRUCTIONS MUST BE FOLLOWED PRECISELY IN ORDER  
TO VALIDATE THE 2 YEAR GUARANTEE**